

Jade Range

Jade Cabinets
Jade Counters

Gastronorm cabinets and counters

A complete redesign of our most popular range of long-standing equipment

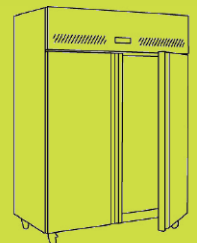
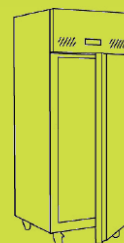
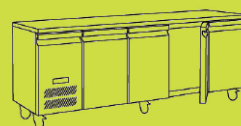

Williams Refrigeration is one of the world's leading manufacturers and suppliers of commercial refrigeration with a reputation for delivering global excellence.

Working with consultants, dealers and customers to create solutions to meet individual requirements, our success lies in a commitment to research, development and innovation.

Save 15%

on energy costs with CoolSmart controller



2, 3 and 4

door counter models available in 3 different temperatures



Features / Benefits

- Full length integral handle for a non-slip, improved 'grab' on the door – a must in a busy kitchen environment. The sleek looking handle is also easy to clean with no potential dirt traps
- Foodsafe professional stainless steel exterior and interior base and aluminium walls for hygiene and durability
- Easy to clean one piece stainless steel dished base with radiused corners for reduced potential dirt traps
- Precision injected, high density 75mm polyurethane insulation. Provides excellent thermal efficiency with low GWP and zero ODP
- Removable racking system with nylon coated shelving for flexibility and ease of cleaning
- Anti-tilt trayslides stops shelves from tipping

- Barrel locked doors for added security and stock control
- Magnetic balloon door gaskets with 100% tight seal
- CoolSmart controller is designed for easy operation and features clear digital display and audio / visual alarms for failsafe performance
- Self-closing doors minimising temperature gain, reducing energy consumption
- Heavy duty, non-marking swivel castors with brakes – designed to fit through a standard door for ease of positioning
- **NEW** Biscuit Top models added to the Jade Counter Range - built without countertops to fit perfectly under prefabricated work surfaces
- 180°C door opening
- Easily reversible door hang

Refrigeration

- Available in a choice of temperature ranges to suit specific requirements.
+1°/+4°C: general produce
-2°/+2°C: fresh meat
-18°/-22°C: frozen food
- Designed and engineered to operate efficiently in a 43°C ambient, Climate Class 5 operation
- The refrigeration systems are removable for easy servicing and maintenance
- Automatic defrost – off cycle 0°C and above, electric below 0°C
- Anti-condensation heaters on models operating below 0°C
- Waste heat recovery vapouriser

One Piece

easy to clean stainless steel dished base

Williams has undertaken a complete redesign of its Jade Range of cabinets and counters.

Designed for effective operation in 43°C high ambient environments the robust, energy conscious Jade has successfully proven itself to withstand the rigours of day-to-day operation in the most stressful of kitchens.



Designed

to suit most budgets

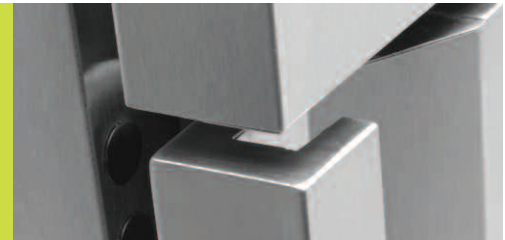

Controls

- CoolSmart controller for increased energy efficiency – saving up to 15% on energy costs
- Adjustable operating temperature for maximum effectiveness, even in the hottest environments
- Fan running indicator
- Defrost indicator
- Compressor running indicator
- Probe failure indicator
- For enhanced temperature management, the Jade is compatible with a wide range of temperature monitoring and control systems

Cabinet Options

- Additional shelving / trayslides
- Left-hand door hang
- Adjustable legs in lieu of castors – add 10mm
- Glass door (high temp only)
- Stainless steel interior







Counter Options

- Additional shelving / trayslides
- Left-hand hung door
- Adjustable legs in lieu of castors – add 10mm
- Drawer banks (2 or 3 drawers)
- Screw-on splashback
- Reverse unit
- Raised panholder
- Wells – full / standard / special
- Stainless steel interior

greenlogic



greenlogic... saving you Energy, Time, Water and Emissions

- Hydrocarbon versions and glycol systems available across the entire Jade range 
- A number of Jade models are listed on the Energy Technology List, thereby eligible for tax relief under the ECA Scheme 
- CoolSmart controller is designed for increased energy efficiency - save up to 15% 
- Self-closing doors with magnetic balloon gaskets - 100% tight seal minimises temperature gain and reduces energy consumption 
- Precision injected, high density 75mm polyurethane insulation, provides excellent thermal efficiency with low GWP and Zero ODP 
- High performance helium leak testing on the entire system 

For further details on how greenlogic can help you, visit the Williams website

www.williams-refrigeration.com



Model	Temp C°	Power Input HP	Running Amps	Shelves	Net capacity Ltrs/Cu.ft
-------	------------	-------------------	--------------	---------	----------------------------

Jade – One Door Cabinet

Internal dimensions W587 x D683 x H1370mm, Door Opening 1450mm

HJ1	+1/+4	1/4	3	3	595/21
MJ1	-2/+2	1/4	3	3	595/21
LJ1	-18/-22	1/2	4	3	595/21

Jade – Two Door Cabinet

Internal dimensions W1250 x D683 x H1370mm, Door Opening 1450mm

HJ2	+1/+4	1/3	3.5	6	1273/45
MJ2	-2/+2	1/3	3.5	6	1273/45
LJ2	-18/-22	3/4	4.5	6	1273/45

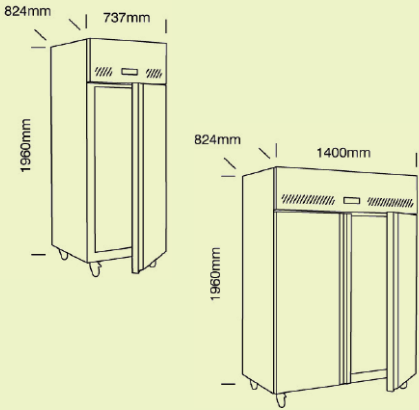

www.williams-refrigeration.com

Jade – Two Door Counter

Internal dimensions W390 (section) x D560 x H600mm, Door Opening 1090mm

HJC2	+1/+4	1/4	3	4	354/12.5
MJC2	-2/+2	1/4	3	4	354/12.5
LJC2	-18/-22	1/2	4	4	354/12.5

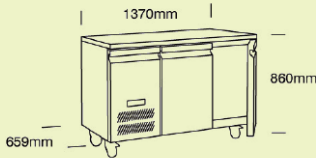

Jade – Three Door Counter

Internal dimensions W390 (section) x D560 x H600mm, Door Opening 1090mm

HJC3	+1/+4	1/3	3.5	6	510/18
MJC3	-2/+2	1/3	3.5	6	510/18
LJC3	-18/-22	1/2	4.5	6	510/18

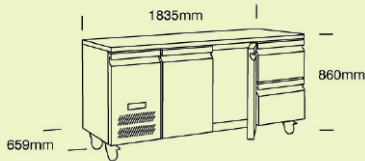

Jade – Four Door Counter

Internal dimensions W390 (section) x D560 x H600mm, Door Opening 1090mm

HJC4	+1/+4	1/3	3.5	8	680/24
MJC4	-2/+2	1/3	3.5	8	680/24

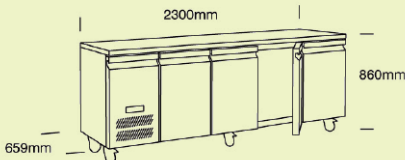

NEW Jade – Two, Three and Four Door Biscuit Top Counter

Door Opening 1090mm, Internal dimensions W390 (section) x D560 x H600mm

Biscuit Top Counter height reduced by 25mm compared to standard JC2, 3 & 4dr counters



For further technical information why not visit our website and download a Technical Datasheet

Installation of all William's products requires adequate ventilation. Williams reserves the right to modify the design, materials and finish in accordance with its progressive development policy

MK/Lit/Jade0610V2

Bryggen Road
North Lynn Industrial Estate
King's Lynn
Norfolk PE30 2HZ

T +44 (0) 1553 817000
F +44 (0) 1553 817111
E info@williams-refrigeration.co.uk